

Term Project Report #2

Official File Based Time Table System

200711472 진교선
200711431 박성훈
200711460 이상열
200711465 이홍재

Design

CONTENTS

- ▶ Introduction
- ▶ UseCase Redefinition
- ▶ Decomposition Description
 - ▶ Class Description
- ▶ Interdependency Description
 - ▶ InterModule Description
 - ▶ InterProcess Description
- ▶ Interface Description
- ▶ Detail Description



Introduction - Purpose

- ▶ **Plan & analysis part 에서 도출한 FR NFR을 충족 시키는 Design을 도출**
 - ▶ Plan & analysis part 에서 부족했던 Use Case를 다시 구상
 - ▶ 이를 통해 Class를 도출해 낸 후 이를 Design에 반영

- ▶ **IEEE Std. 1016을 기준으로 SSD 작성**
 - ▶ Design에 대한 명세를 문서화 한다.



Introduction - Scope

- ▶ Plan & analysis part에서 도출된 내용만을 Design에 반영

- ▶ Plan & Analysis 에서 규정한 Scope를 준수한다.



UseCase Redefinition

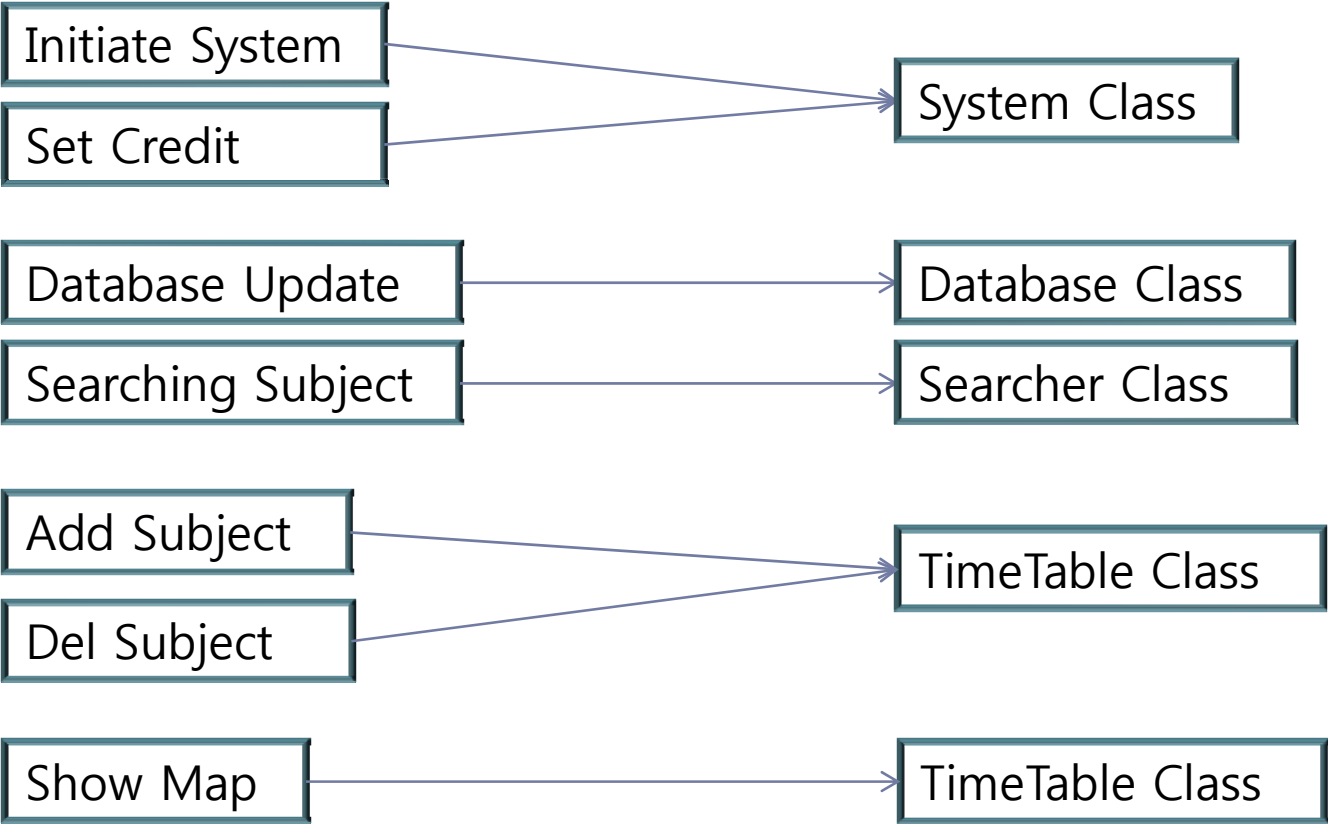

Class Description

▶ System Class Description

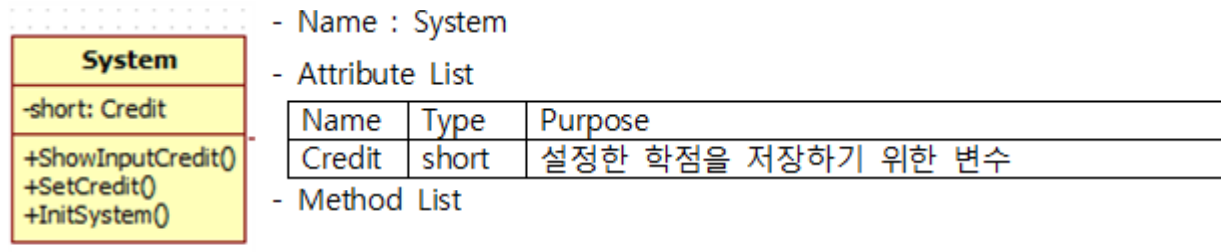

Name	Return Type	Parameter	Purpose
ShowInputCredit	void	void	credit을 화면에 출력
SetCredit	Void	short	credit Attribute 값을 설정한다.
InitSystem	Void	void	System 초기화

▶ Searcher Class Description

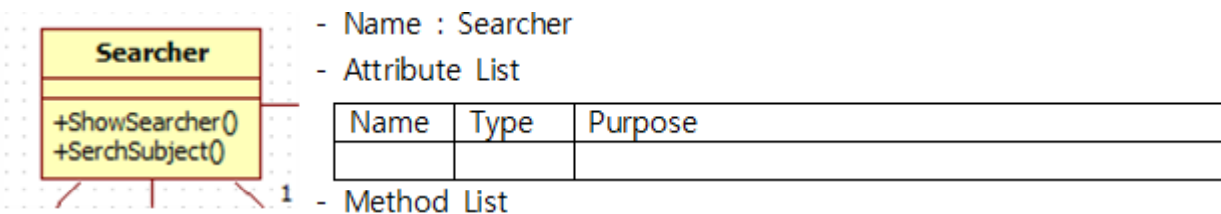

Name	Return Type	Parameter	Purpose
ShowSearcher	void	void	Search UI 화면에 출력
SearchSubject	void	string,string	parameter의 조건으로 database 검색

Class Description

▶ TimeTable Class Description

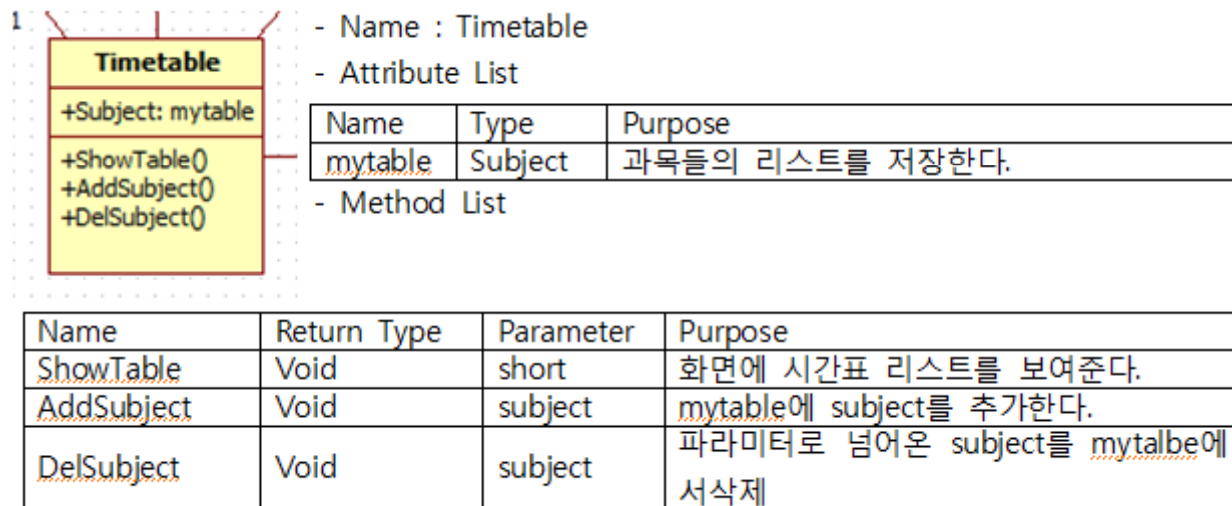

Class Description

▶ Map Class Description

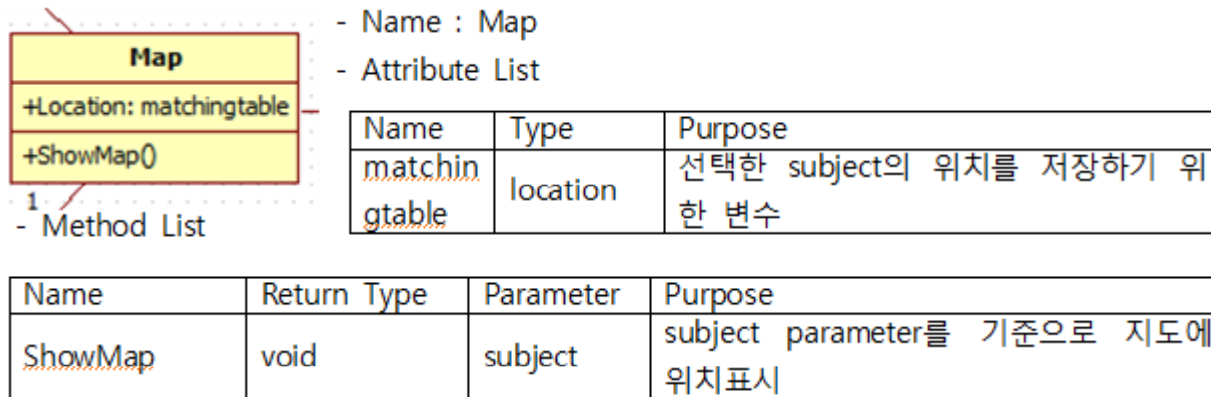

▶ Database Class Description

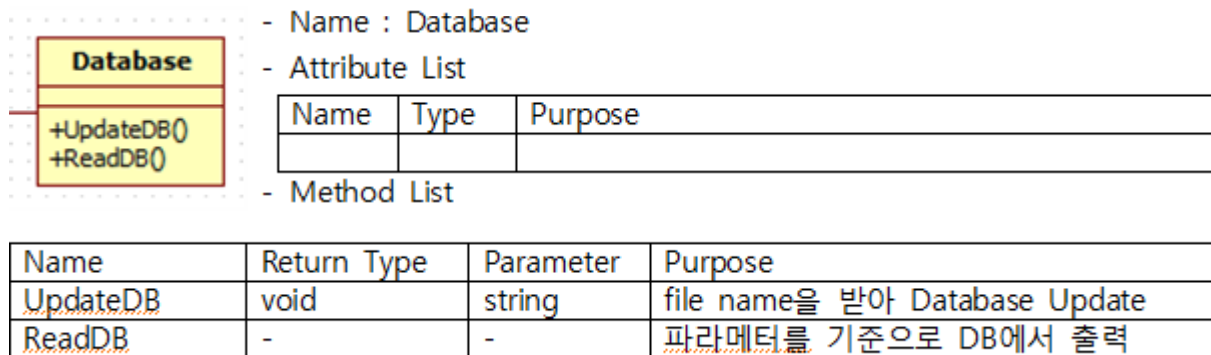

InterModule Description

▶ Table Package

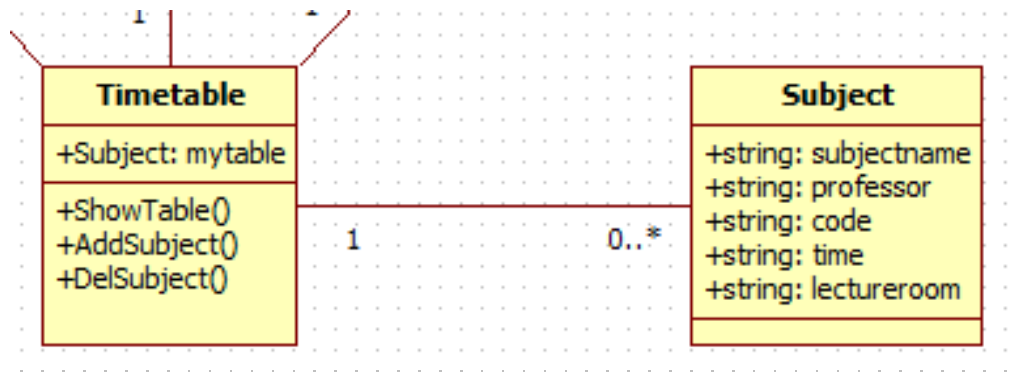

▶ Locale Package

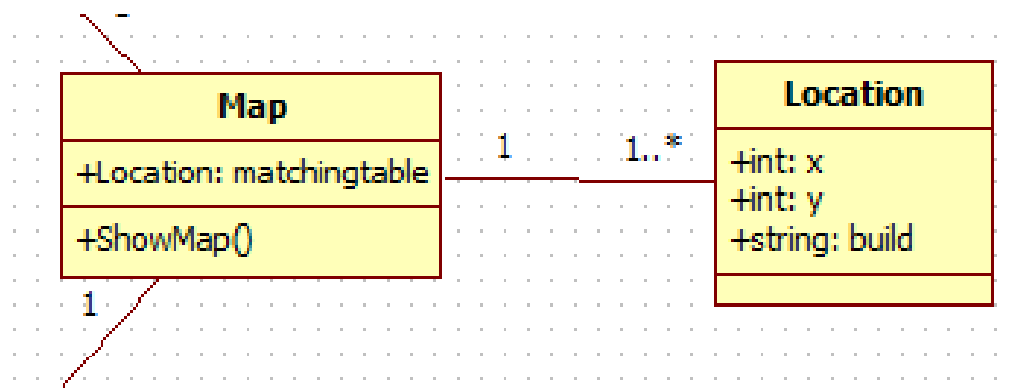

InterModule Description

▶ Database Handler Package

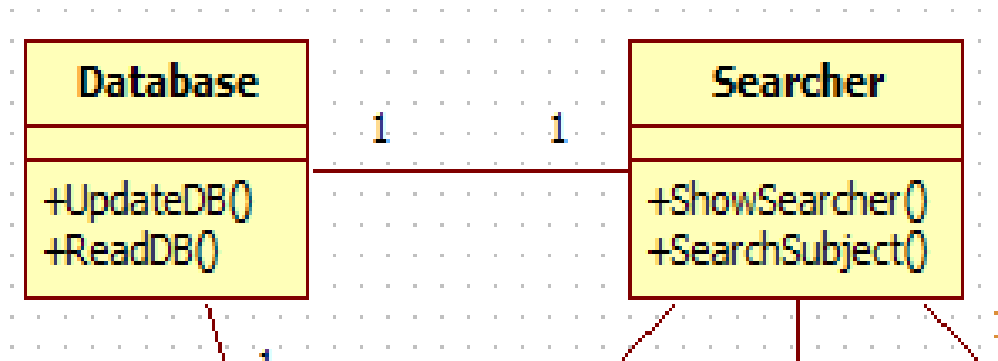

▶ Main System Package

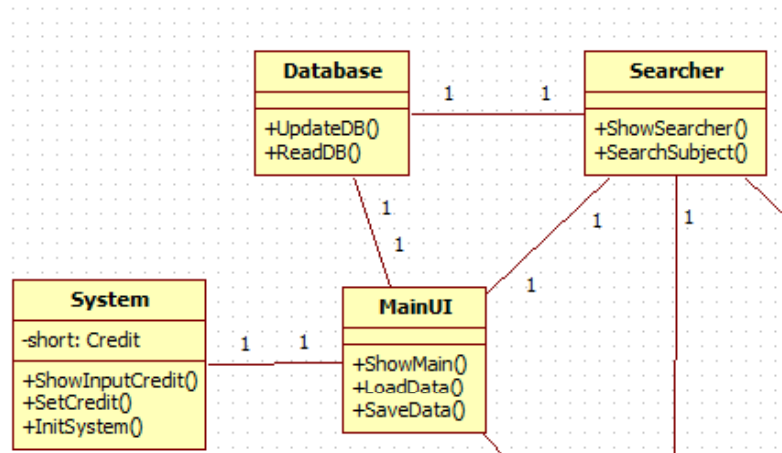

InterModule Description – Over All

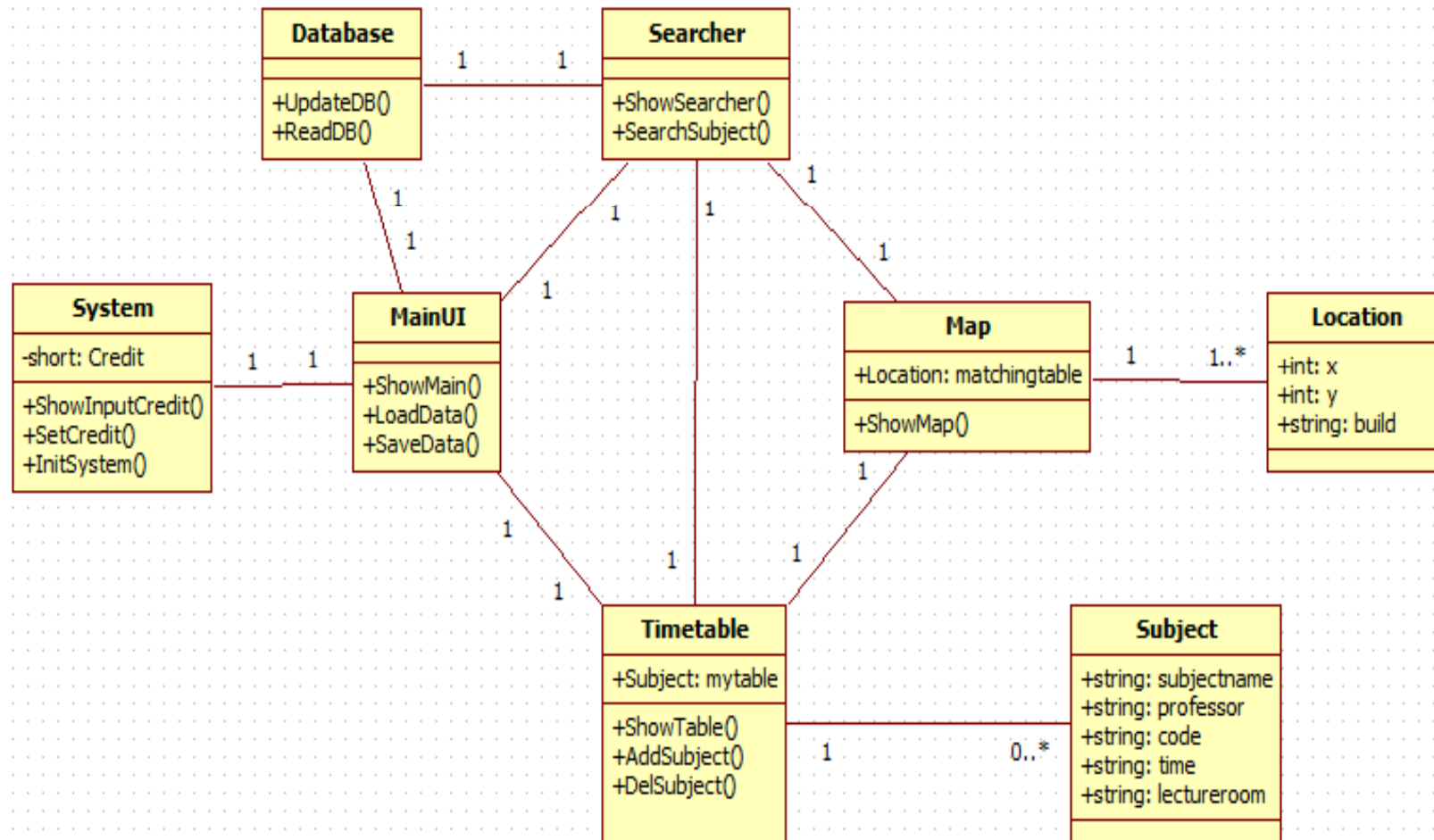

InterProcess Description

- ▶ Sequential Description for Displaying Map

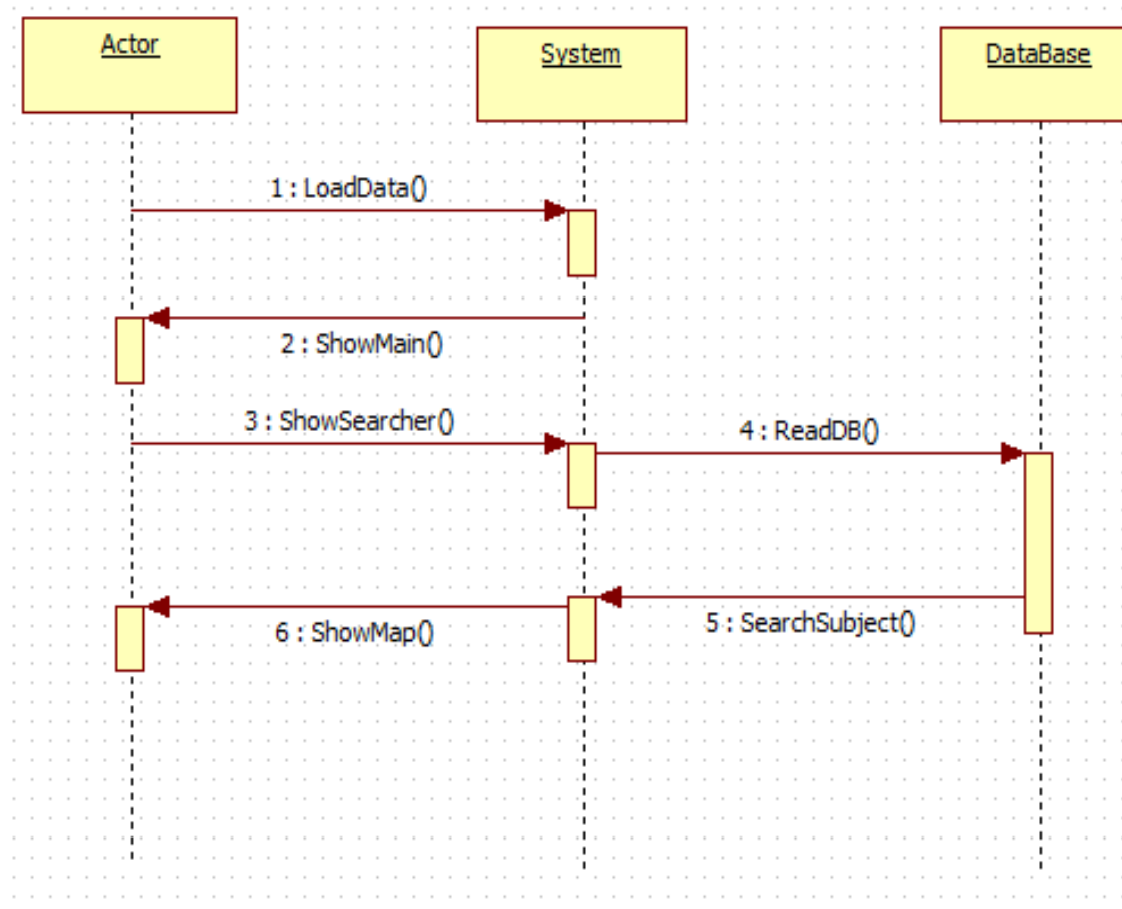

InterProcess Description

- ▶ Sequential Description for Displaying Map

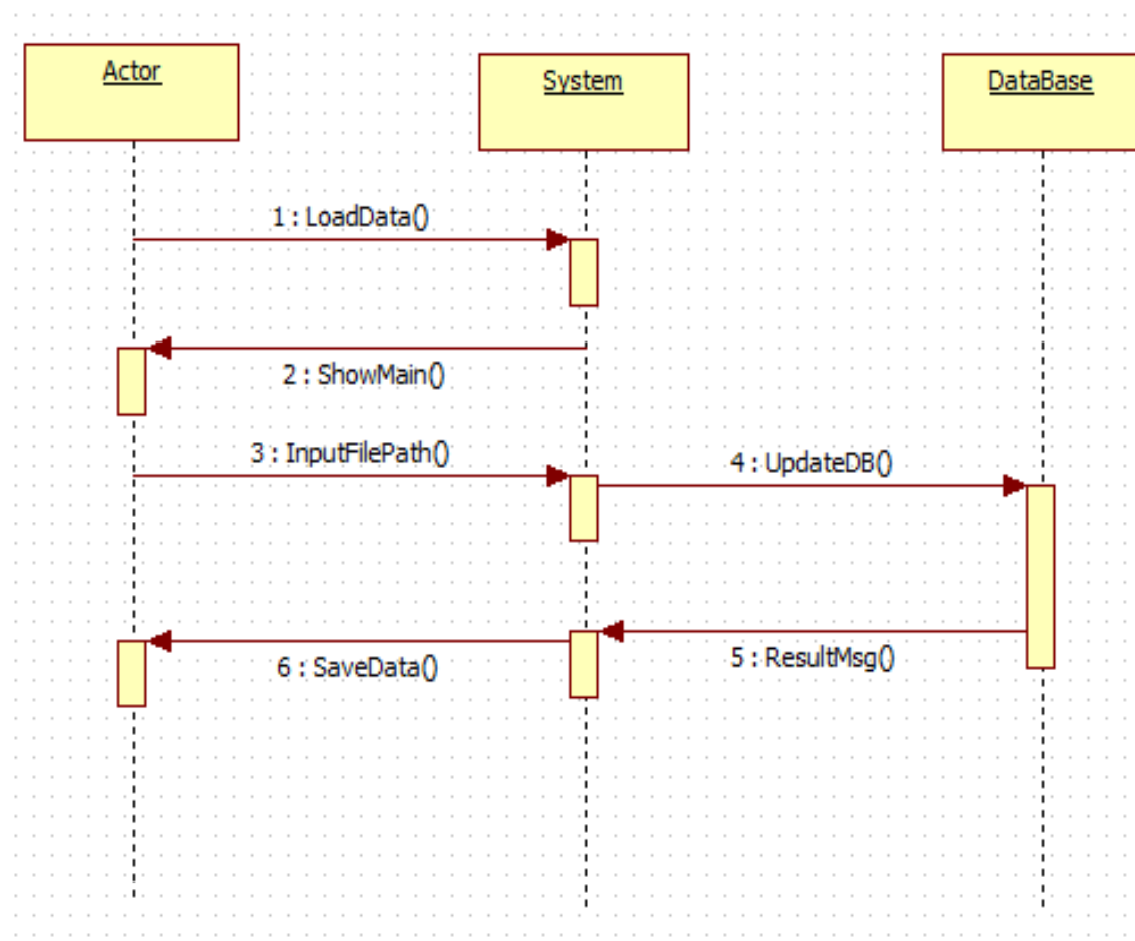

Interface Description

▶ Main UI

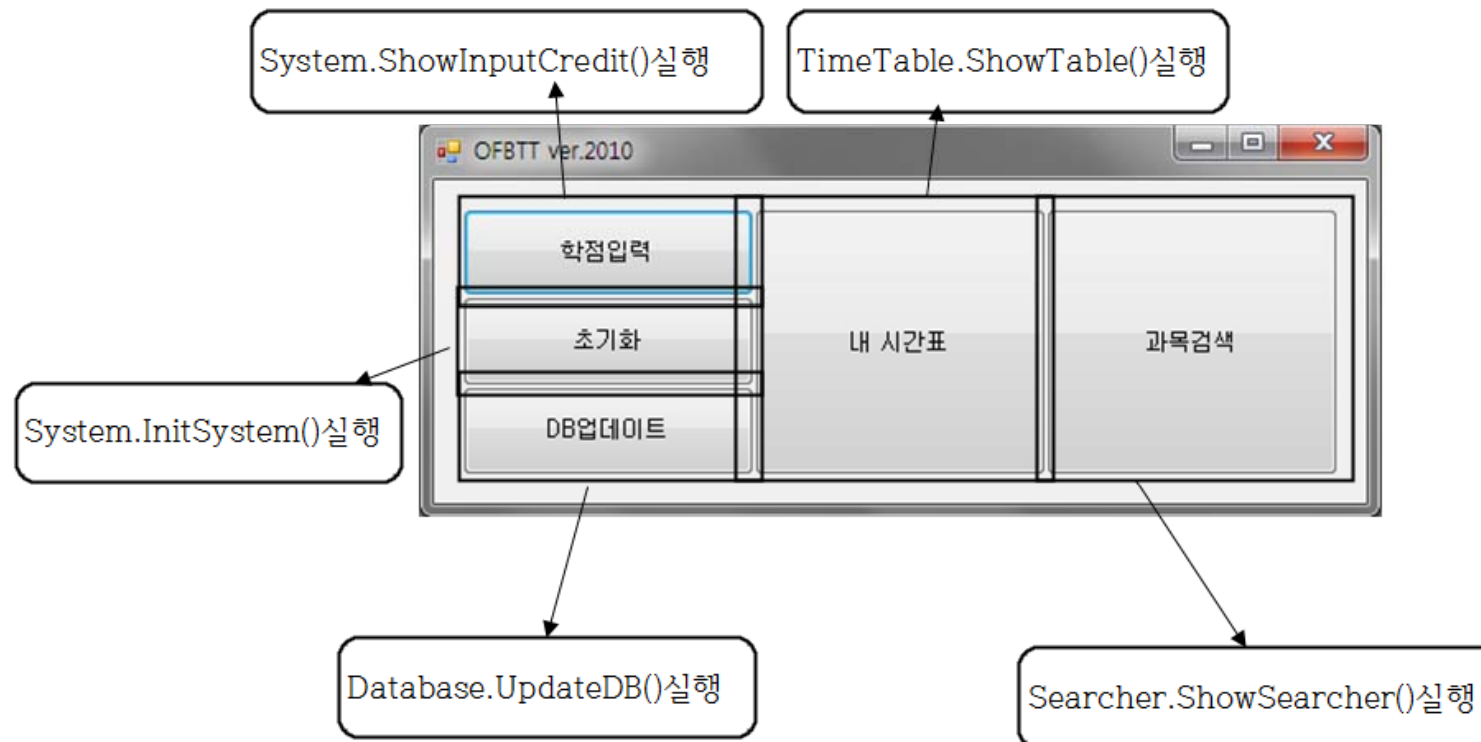

Interface Description

▶ Initiate System UI

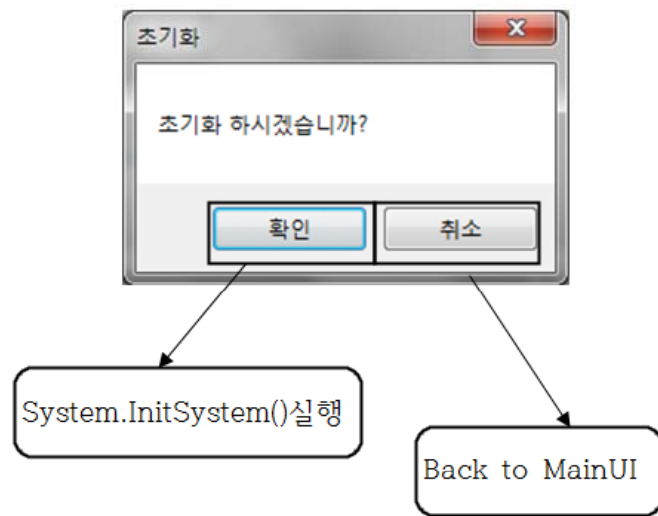

▶ Set Credit UI

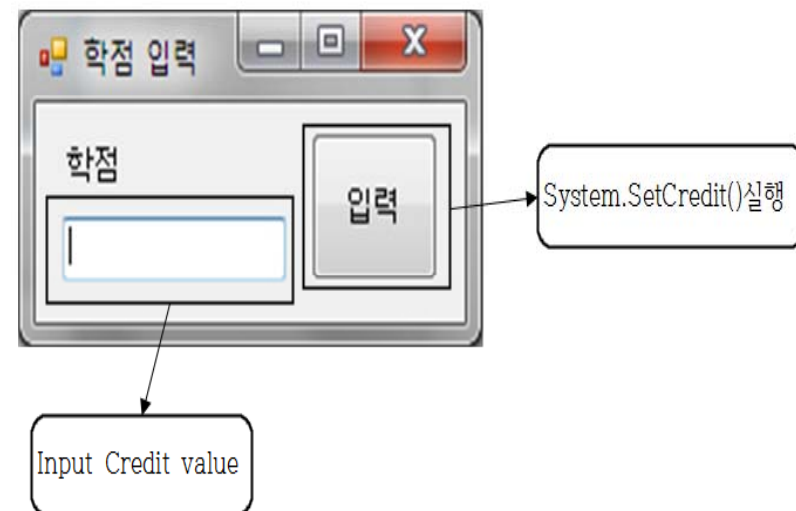

Interface Description

▶ ShowSearcher UI



▶ ShowSearcher UI

